

Standard Cylinder Accessories

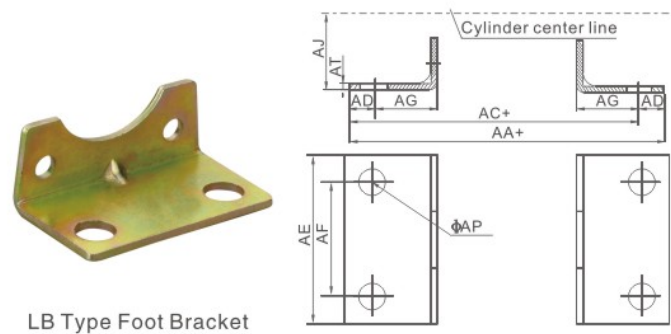

LB Type Foot Bracket

Symbol/Bore	32	40	50	63	80	100	125	160	200
AA	153	169	173	184	199	210	249	328	380
AC	134	140	149	158	167	174	213	288	320
AD	9.5	14.5	12	13	16	18	18	20	30
AE	50	57	68	80	97	112	140	180	220
AF	33	36	47	56	70	84	90	115	135
AG	20.5	23.5	28	31	30	30	45	60	70
AJ	28	30	36.5	41	49	57	90	115	135
AP	9	12	12	12	14	14	16	18	24
AT	3	3	3	3	4	4	8	8	10

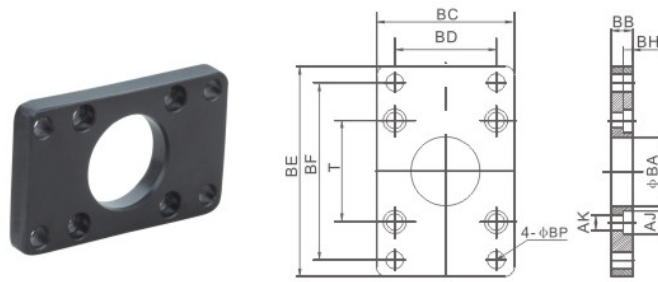

FA/FB Type Flange

Symbol/Bore	32	40	50	63	80	100	125	160	200
BA	28.3	32.3	38.3	38.3	47.3	47.3	56	63	81
BB	10	10	10	12	16	16	16	20	25
BC	47	52	65	76	95	115	140	180	220
BD	33	36	47	56	70	84	90	115	135
BE	72	84	104	116	143	162	224	280	320
BF	58	70	86	98	119	138	180	230	270
BH	6.5	6.5	6.5	8.5	10.5	10.5	10.5	12.5	16.5
AJ	10.5	10.5	13.5	13.5	5	5	19	25	25
AK	6.5	6.5	6.5	8.5	10.5	10.5	12.5	16.5	16.5
BP	7	7	9	9	11	11	16	18	22
T	33	37	47	56	70	84	110	140	175

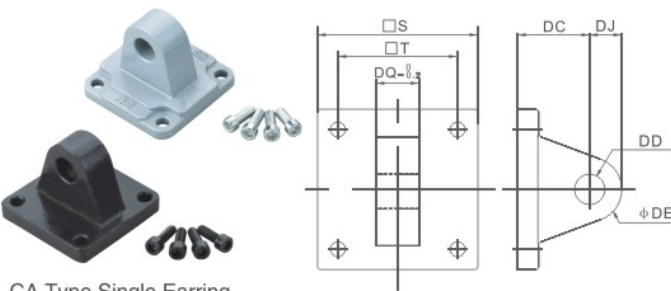

CA Type Single Earring

Symbol/Bore	32	40	50	63	80	100	125	160	200
S	48	50	62	75	94	112	140	180	220
T	33	37	47	56	70	84	110	140	175
DC	34	34	34	34	48	48	50	55	60
DD	14	14	14	14	20	20	25	30	30
DE	12	14	14	14	20	20	25	30	30
DJ	14	14	15	15	20	20	25	30	30
DQ	16	20	20	20	32	32	70	90	90

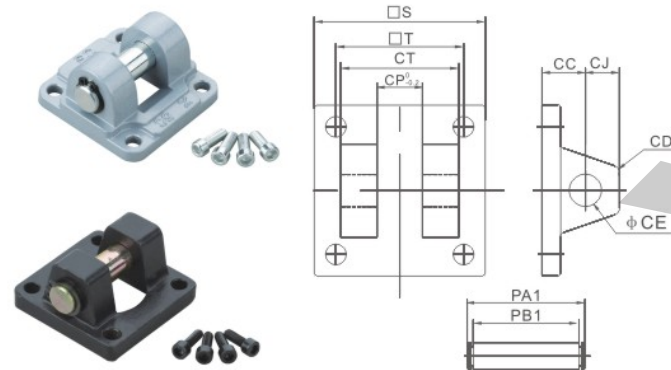

CB +Pin Type Double Earring

Symbol/Bore	32	40	50	63	80	100	125	160	200
CC	19	19	19	19	32	32	50	55	60
CD	5	5	3	2	8	8	25	30	30
CE	12	14	14	14	20	20	25	30	30
CJ	13	13	15	15	21	21	25	30	30
CP	16	20.5	20.3	20.3	32.3	32.3	70	90	90
CT	32	44	52	52	64	64	120	160	160
PAI	41	51.8	60.3	60.3	73.8	73.8	130	170	170
PBI	33.5	45.8	54	54	65.5	65.5	121.5	161.5	161.5
S	48	50	62	75	94	112	140	180	220
T	33	37	47	56	70	84	110	140	175

Note: CA and CB From 32-100, we can supply two kinds of materials products: 1. Iron 2. Aluminum. When placing order, please indicate product material. From 125-200 are all iron.

Standard Cylinder Accessories



Y+Pin Type Joint

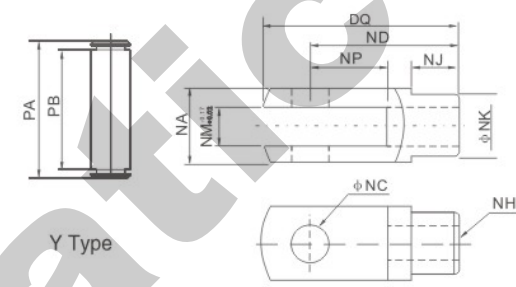

Y Type

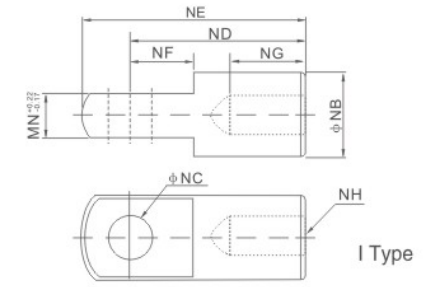

I Type

Symbol/Bore	32	40	50	63	80	100	125	160	200
NA	19	25.4	32	32	44.4	44.4	64	80	80
NB	20	24	32	32	40	40	45	54	54
NC	10	12	16	16	20	20	20	30	30
ND	40	48	64	64	80	80	102	120	120
NE	52	67	89	89	112	112	121	130	130
NF	15	24	32	32	40	40	52	35	35
NG	20	20	23	23	30	30	56	50	50
NH	M10×1.25	M12×1.25	M16×1.5	M16×1.5	M20×1.5	M20×1.5	M27×2	M36×2	M36×2
NJ	12	20	22	22	30	30	27	40	40
NK	18	23	30	30	39	39	38	54	54
NM	10	12	16	16	20	20	32	40	40
MP	20	24	32	32	40	40	35	35	35
NQ	52	62	83	83	105	105	122	150	150
PA	25	32.8	39.3	39.3	53.3	53.3	74	91	91
PB	19.5	26.5	33	33	45	45	63.5	81	81



I Type Joint



TC Type

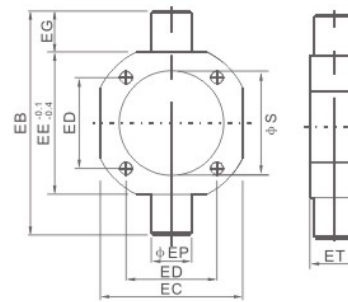

Symbol/Bore	32	40	50	63	80	100	125	160	200
EB	88.5	113	126	138	164	182	210	264	320
EC	52	63	76	88	114	132	160	200	248
ED	33	37	47	56	70	84	110	140	175
EE	55	63	76	88	114	132	160	200	248
EG	16.75	25	25	25	25	25	25	32	36
EP	16	25	25	25	25	25	25	32	32
ET	30	30	30	30	30	35	35	41	49
S	37.5	45.5	56.5	68.5	87.5	107.5	134.5	172.5	219.5



TC-M Type

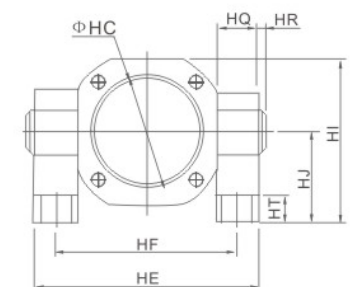
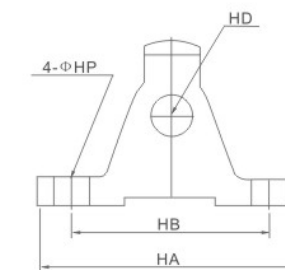

Symbol/Bore	HA	HB	HC	HD	HE	HF	HI	HJ	HQ	HR	HT	HP
40	110	80	45.5	22	109	86	81.5	50	23	2	12	12
50	110	80	55.5	22	122	99	88	50	23	2	12	12
63	110	80	68.5	22	134	111	94	50	23	2	12	12
80	120	85	87.5	22	160	137	127	70	23	2	14	14
100	120	85	107.5	22	178	155	136	70	23	2	14	14