

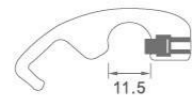

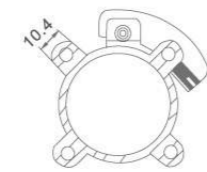

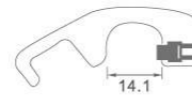

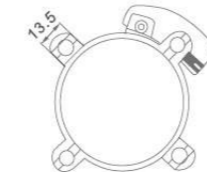

PI / PAC Series Bracket

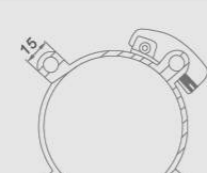

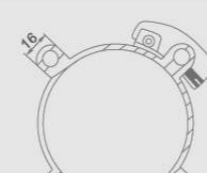
PI Series Bracket

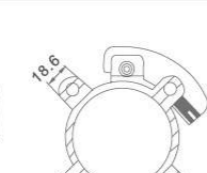
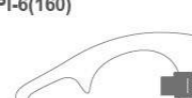
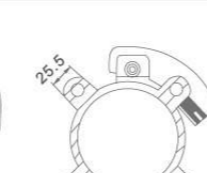
Bracket is designed for mounting XC-21 series sensor on ISO profile cylinder.(mickey mouse Type)

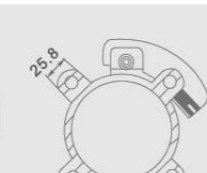
| Product   | Dimension/Installation  |  |
|---|---|--|
|    | <b>PI-1(32/40)</b><br> 11.5<br> 10.4    | <b>PI-2(50/63)</b><br> 14.1<br> 13.5  |
|    | <b>PI-3(80)</b><br> 14.45<br> 15        | <b>PI-4(100)</b><br> 16.3<br> 16      |
|   | <b>PI-5(125)</b><br> 19.38<br> 18.6   | <b>PI-6(160)</b><br> 27.35<br> 23.5 |
|  | <b>PI-7(200)</b><br> 28.66<br> 25.8 |  |

PAC Series Bracket

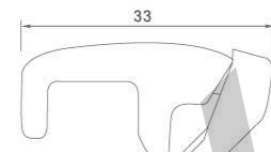
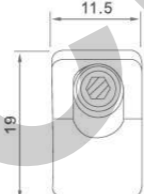











Bracket is designed for mounting XC-21 series on tie-rod cylinder.

| Product   | Dimension/Installation  |
|---|---|
|  |  33<br> 11.5<br> Diameter of tie-rod<br>19<br>Using for tie-rod cylinder $\Phi 32-\Phi 100$ , hydraulic cylinder (tie-rod bore $\Phi 4-\Phi 10$ ) |

PM / SU Series Bracket









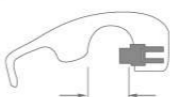
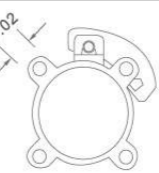
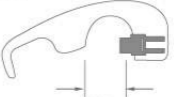
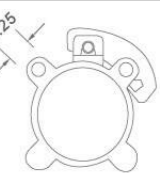

PM Series Bracket

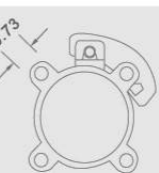
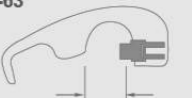
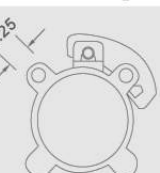
Bracket is designed for mounting XC-21 series on tie-rod cylinder.

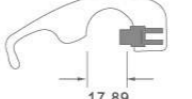
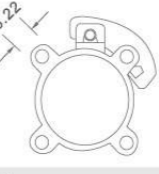
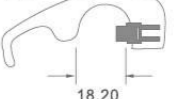
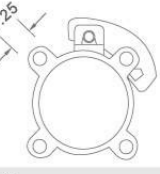
| Product   | Dimension/Installation   |  |
|---|--|--|
|  | <b>PM-6(32/40/50)</b><br> Dia. of Tie rod: $\Phi 5-\Phi 6$<br> | <b>PM-8(63)</b><br> Dia. of Tie rod: $\Phi 8$<br>    |
|  | <b>PM-10(80/100)</b><br> Dia. of Tie rod: $\Phi 10$<br>        | <b>PM-12(125)</b><br> Dia. of Tie rod: $\Phi 12$<br> |
|  | <b>PM-16(160/200)</b><br> Dia. of Tie rod: $\Phi 16$<br>       |  |

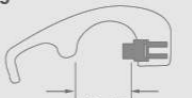
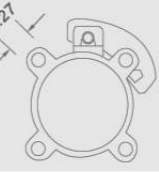
SU Series Bracket

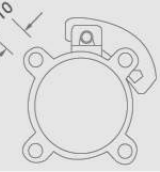
Bracket is designed for mounting XC-21R sensor on mickey mouse Type cylinder (SUType).

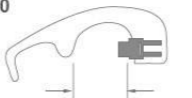
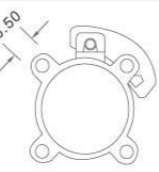
| Product   | Dimension/Installation  |   |
|---|---|---|
|  | <b>SU-32</b><br> 10.50<br> 10.02  | <b>SU-40</b><br> 11.01<br> 10.25  |
|  | <b>SU-50</b><br> 11.43<br> 10.73  | <b>SU-63</b><br> 11.01<br> 10.25  |
|  | <b>SU-80</b><br> 17.89<br> 16.22  | <b>SU-100</b><br> 18.20<br> 17.25 |
|  | <b>SU-125</b><br> 19.10<br> 18.27 | <b>SU-160</b><br> 25.49<br> 24.10 |
|  | <b>SU-200</b><br> 26.50<br> 25.50 |   |